

bemodern

FIREPLACES & STOVES | BATHROOM FURNITURE

Model 2840

Qube Electric Freestanding Stove

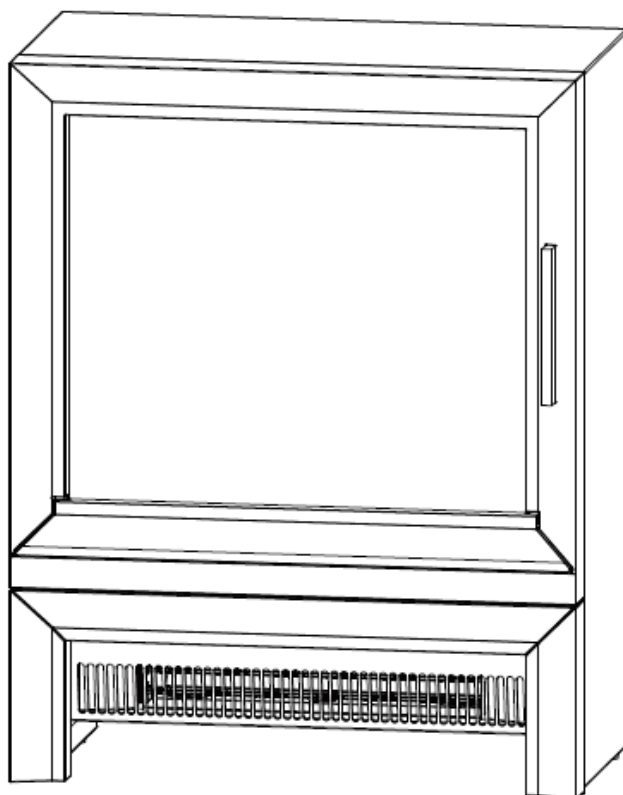

Instructions for use

This product is only suitable for well insulated spaces or occasional use

Contents

Tech Specs	3
Safety Info	4 – 5
User Instructions	6 - 8
Maintenance	9
General information	10
Guarantee	11

Technical Specification

Model No.: 2840

Supply Voltage: AC 230-240V 50Hz

Maximum power consumption: 2KW

Power for flame effect: 9W (LED 5W + Motor for flame 4W)

Heat Output:

Nominal heat output (P_{nom}): 2.0KW

Minimum heat output (indicative) (P_{min}): 1KW

Maximum continuous heat output (P_{max}): 2.0KW

Auxiliary Electricity Consumption:

At nominal heat output (e_{lmax}): N / A

At minimum heat output (e_{lmin}): N / A

In standby mode (e_{lSB}): 0kW

Type of heat output / room temperature control

Single stage heat output and no room temperature control	No
Two or more manual stages, no room temperature control	No
With mechanic thermostat room temperature control	Yes
With electronic room temperature control	No
Electronic room temperature control plus day timer	No
Electronic room temperature control plus week timer	No

Other Control Options

Room temperature control, with presence detection	No
Room temperature control, with open window detection	No
With distance control option	No
With adaptive start control	No
With working time limitation	No
With black bulb sensor	No

Safety Information

Read all of the instructions carefully before using the appliance.

For indoor use only This appliance is not suitable for use outside the house and **only suitable for well insulated spaces or occasional use.**

Do not use this appliance in the immediate surroundings of a bath, a shower or a swimming pool or any wet area

This fire must not be located immediately below or above a socket-outlet.

This appliance must be earthed.

This appliance must not be supplied through an external switching device, such as a timer, or connected to the circuit that is regularly switched on and off by utility in order to avoid a hazard due to the inadvertent resetting of the thermal cut out.

A non-rewirable plug fitted with a 13A fuse is supplied. Should the fuse or plug need replacing, and you are competent to do so, it must be replaced with a 13A fuse or plug being 13A BS1363A approved.

If the power cord is damaged, it must be repaired by the manufacturer, its authorised service centre or professional person.

The meaning of this symbol  is "DO NOT COVER". **Warning:** in order to avoid overheating, do not allow the appliance to be covered or let the air inlet / outlet to become obstructed. Please note the warning symbol on the appliance (see above).

To reduce the risk of fire, keep textiles, curtains, or any other flammable material a minimum distance of 1 meter from the air outlet.

Keep the power cord away from hot surfaces and hot conditions. Do not route the power lead in front of the appliance.

Do not use this fire in rooms that have explosive gas in them (for example petrol), or if you are using solvents, glue, aerosol spray or in flammable paints, as these may catch fire.

Safety Information *(continued)*

Children and vulnerable people must be supervised at all times when using this appliance, as some parts can become very hot and cause burns.

This appliance shall not be played with by children.

Children of less than 3 years should be kept away unless continuously supervised.

Children aged from 3 years and less than 8 years only can switch on / off the appliance provided that it has been placed or installed in its intended normal operating position and instructions and supervisions concerning the safe way of the use of the appliance are offered. Children aged from 3 years and less than 8 years shall not plug in, regulate and clean the appliance or perform user maintenance.

This appliance can be used by children aged from 8 years and above and persons with reduced physical, sensory or mental capabilities or lack of experience and knowledge if they have been given supervision or instruction concerning use of the appliance in a safe way and understand the hazards involved.

Do not use this appliance in small rooms when they are occupied by persons not capable of leaving the room on their own, unless constant supervision is provided.

Cleaning and user maintenance shall not be made by children without supervision.

User Instructions

This model has been designed to be free standing and positioned a minimum of 30mm from a wall to the rear and sides. Please maintain the minimum clearances.

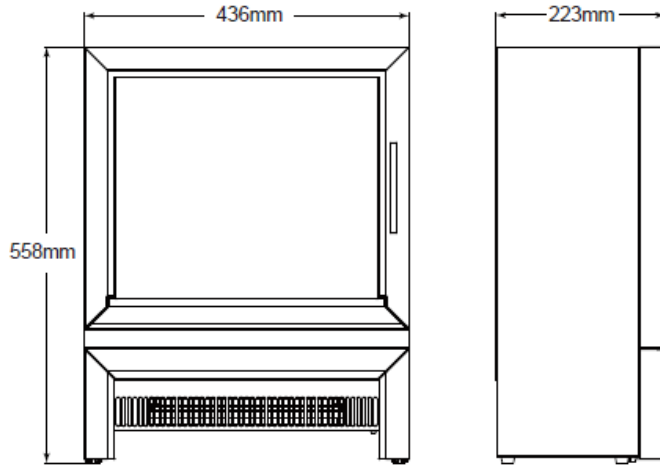

WARNING! Do not operate the appliance if it is damaged or has malfunctioned. If you suspect the appliance is damaged or has malfunctioned call a qualified service engineer to inspect the appliance, and replace any part of the electrical system if necessary, before reuse.

WARNING! To reduce the risk of fire, keep textiles, curtains, or any other flammable material a minimum distance of 1 meter from the air outlet.

MAKE SURE the plug fits tight in the outlet. Faulty wall outlet connections or loose plugs can cause the outlet to overheat.

Do not disconnect the power at the mains supply whilst the appliance is running. Ensure the mains switch has been moved to the off position before disconnecting.

Main Power Switch

The main power switch is located under the flap on the front of the appliance. This needs to be switched ON before operating the manual controls.

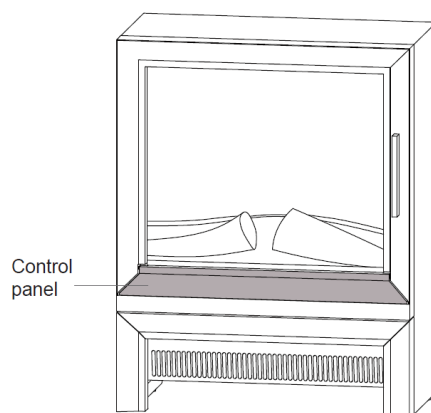

User Instructions *Continued*

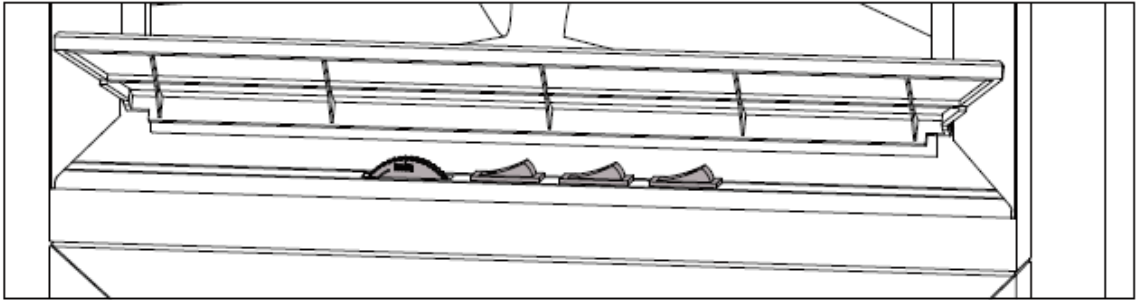

The appliance incorporates a flame effect, which can be used with or without the heating so the comforting effect can be enjoyed at any time of the year.

The flame effect must be on to use the heater.

To operate the flame effect only switch 1 must be in the "I" position.

Using the appliance with flame effect and 1kW heat setting both switch 1 and 2 must be in the "I" position.

To use the appliance with the flame effect and maximum heat out put (2kW), switch 1, 2 and 3 must be in the "I" position.

Please note that this appliance uses a motor to operate the flame effect and it may be possible to hear this when the background noise is low. This is normal and should not be a cause of concern

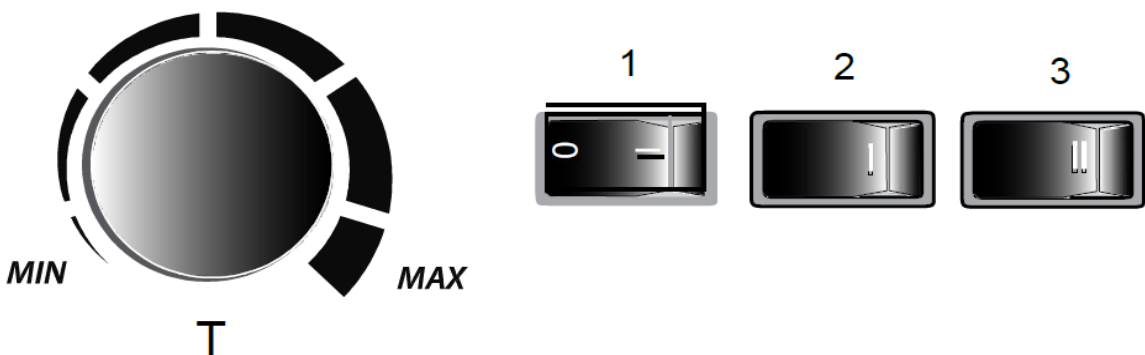

To maintain a certain room temperature, set the thermostat (T) to "Max". Operate the heater on full power until the required room temperature is reached, then turn the thermostat knob towards "Min" until it turns off with an audible clip. This temperature will be kept almost constantly by the thermostat switching the heater ON and OFF automatically. Please note the heater can only be switched ON when the thermostat setting is higher than the room temperature.

Resetting the Thermal Cut Out

The appliance is fitted with an Electronic Safety Control (E.S.). This is a safety device, which switches off the fire if, for any reason, the appliance overheats, e.g. if covered. If the heater stops operating while the flame effect continues working normally, this indicates that the E.S. Control is in operation. The E.S. Control can only be reset after the appliance has cooled down, and the appliance has been reset. Resetting of the E.S. Control proceeds as follows:

Switch off the appliance (On / Off switch), unplug or switch off from wall socket and leave it off for approximately 10 -15 minutes.

Remove any obstruction to the fan heater outlet or fan blades etc. Make sure that the power supply is disconnected at the plug socket outlet while doing this.

Plug back in to the mains socket, switch on the appliance and the E.S. Control will be re-set.

Ensure that the appliance is functioning correctly. If the E.S. Control operates again, the appliance should be checked by a competent electrician.

Maintenance

WARNING: Before any maintenance or whilst cleaning the exterior of the fireplace, the unit should be disconnected from the power supply until it has cooled down.

Cleaning the Fire

Cleaning or polishing products are not recommended. Fingerprints or other marks on the front glass panel can be removed by a piece of soft, damp, lint-free cloth with a good quality household glass cleaner. The front glass panel should always be completely dried with a clean, lint-free cloth or paper towel.

CAUTION: Abrasive cleaners should not be used on the glass panel. Liquids should not be sprayed directly onto any surface of the unit.

Electrical Connections - UK Plug Wiring Instruction

If the plug has to be changed because it is not suitable for your socket, or due to damage, please follow the wiring instructions shown below.

The wires in the mains lead are coloured in accordance with the following code:

BROWN	:	LIVE (L)
BLUE	:	NEUTRAL (N)
GREEN / YELLOW	:	EARTH (E)

As the colours of the wires in the mains lead of this appliance may not correspond with the coloured markings identifying the terminals in your plug, as follows

The BLUE wire is the NEUTRAL and must be connected to the terminal which is marked with the letter N or coloured BLACK.

The BROWN wire is the LIVE and must be connected to the terminal that is marked with the letter L or coloured RED.

The wire which is coloured GREEN / YELLOW must be connected to the terminal which is marked E or the earth symbol or coloured GREEN or GREEN / YELLOW.

Always ensure that the cord grip is positioned and securely fastened.

WARNING: THIS APPLIANCE MUST BE EARTHED.

If a 13A (BS1363) fused plug is used it must be fitted with a BS1362 13A fuse. If in doubt consult a qualified electrician.

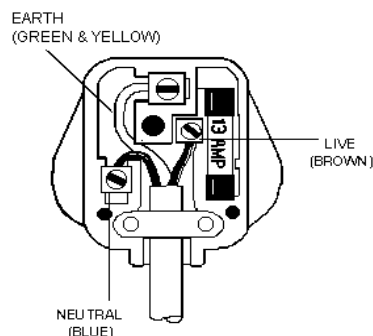

General Information

Environment



Meaning of crossed-out wheeled dustbin:

Electrical appliances should not be disposed as unsorted municipal waste. Separate collection facilities should be used in the disposal of electrical appliances. Contact your local government for the information about the available collection systems. If electrical appliances are disposed of in landfills or dumps, hazardous substances can leak into the groundwater and get into the food chain, damaging your health and well-being. When old appliances are replaced by the new ones, it is a legal obligation for the retailer to take back the old appliance for disposals at least free of charge.



This fire complies with the Safety Standards EN 60335-1 and EN 60335-2-30 which covers the essential requirements of the Low Voltage Directive 2014/35/EU and the EMC standards EN 55014-1; EN 55014-2; EN 61000-3-2 and EN 61000-3-3 which covers the essential requirements of the European Electro Magnetic Compatibility 2014/30/EU, and the RED standards EN300220-2, EN301489-1, EN301489-3 and EN6247 which covers the essential requirements of the European Radio Equipment Directive 2014/53/EU.



RoHS stands for Restriction of Hazardous Substances, and impacts the entire electronics industry and many electrical products as well. The original RoHS, also known as Directive 2002/95/EC, originated in the European Union in 2002 and restricts the use of six hazardous materials found in electrical and electronic products. All applicable products in the EU market since July 1, 2006 must pass RoHS compliance.

Electric Fire Guarantee

Be Modern Ltd. (the 'Company') provides a **twelve month** guarantee in respect of electric fire (the 'Product') ranges.

1. The twelve month Guarantee applies to:

- a. All products in the ranges manufactured by the 'Company' (but subject to the exceptions below): where:
- b. The product has been purchased and installed within the UK and in respect of
- c. The initial installation: and in favor of
- d. The original purchaser

2. Proof of Purchase must be retained by the Purchaser

3. The twelve month Guarantee does not apply to:

- a. Damage or inferior workmanship practices whilst the 'Product' is being installed
- b. Damage caused by mis-use of the 'Product' or where normal standards of care and use have not been complied with.
- c. Damage through a malfunction or an inadequately installed electric fire.
- d. Damage or defects due to mis-use, accident or unauthorised alterations.

4. During the twelve month after the "Product" has been supplied, the Guarantee covers the making good (whether by repair or replacement at the Company's option) of defects arising from defective manufacture of materials of "Product" covered in Para 1 all at no cost to the purchaser on the provision:

- a. The Product has been installed as per Be Modern recommendations. The Purchaser uninstalls the Product and makes it available for collection by Be Modern.

This Guarantee does not affect your statutory rights

On requiring service the purchaser should contact the retailer who supplied your product who will assist and advise you as necessary.

Be Modern Ltd.
19/34 Bedesway
Bede Industrial Estate
Jarrow
Tyne and Wear
NE32 3BE
Tel: (0191) 430 0901
Fax: (0191) 430 9522
<http://www.bemodern.com>